

Perimeter of a rectangle

1 Work out the perimeter of each rectangle.

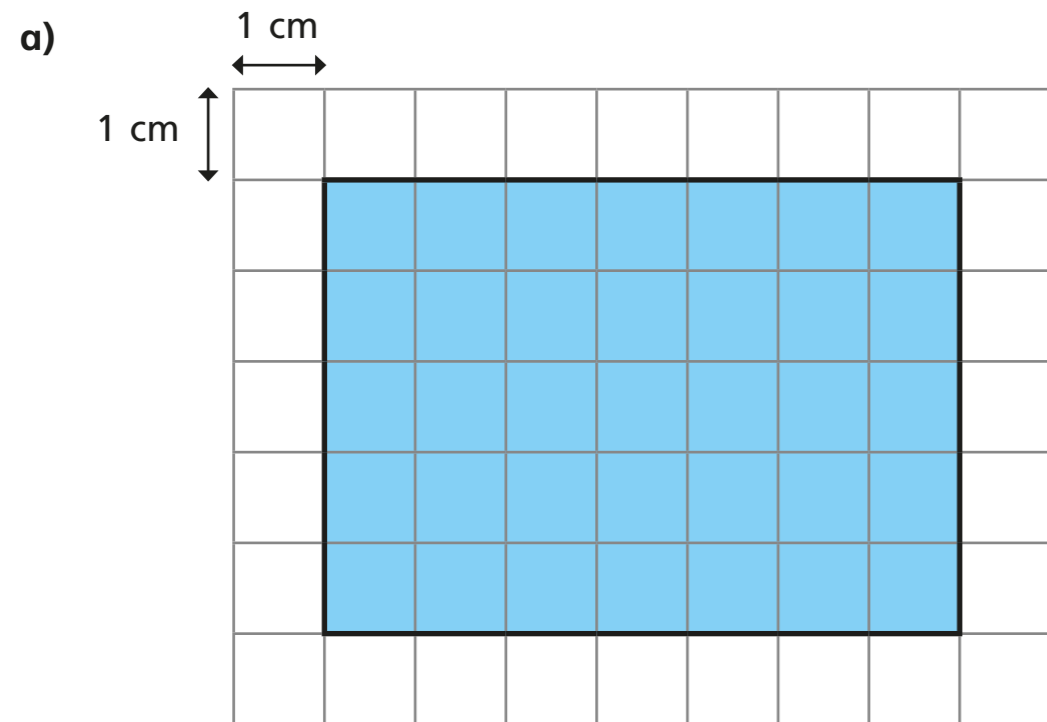

$$\square \text{ cm} + \square \text{ cm} + \square \text{ cm} + \square \text{ cm} = \square \text{ cm}$$

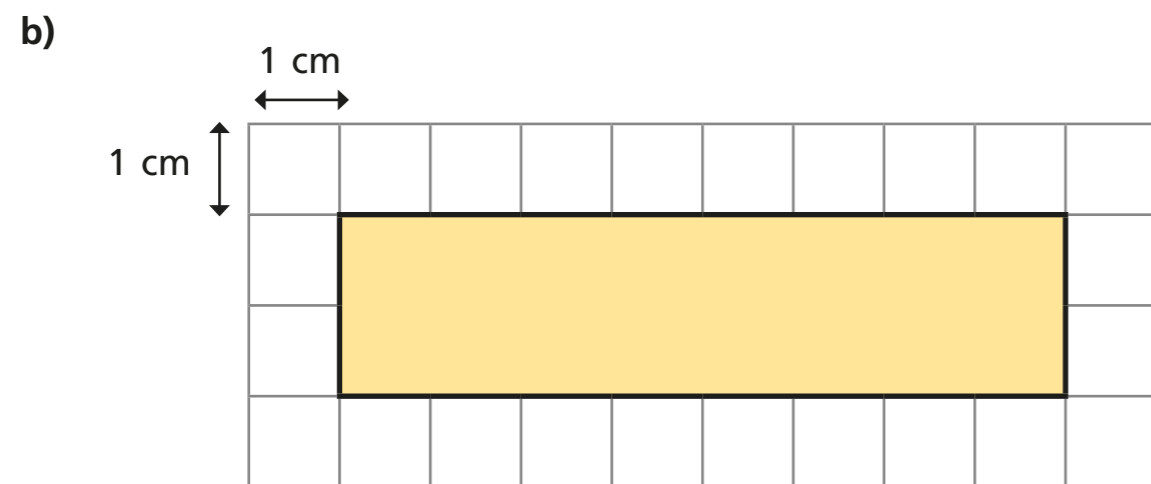

$$\square \text{ cm} + \square \text{ cm} + \square \text{ cm} + \square \text{ cm} = \square \text{ cm}$$

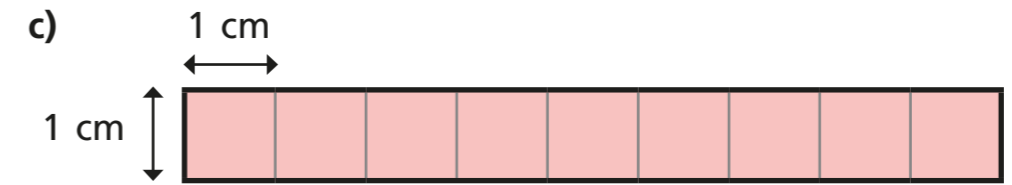

$$\square \text{ cm} + \square \text{ cm} + \square \text{ cm} + \square \text{ cm} = \square \text{ cm}$$

2 Work out the perimeter of the rectangles.

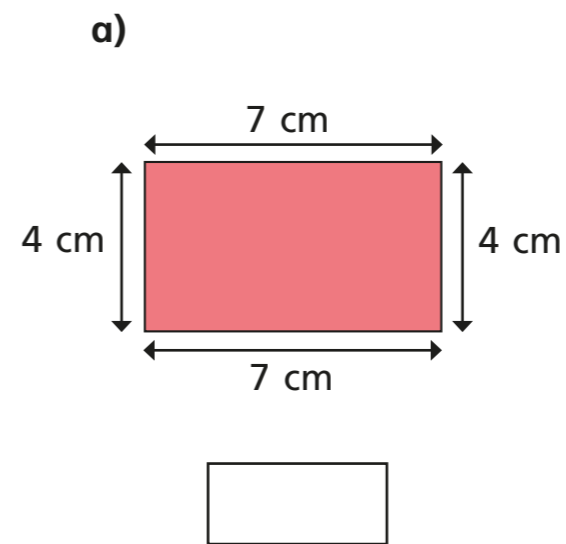

$$\square$$

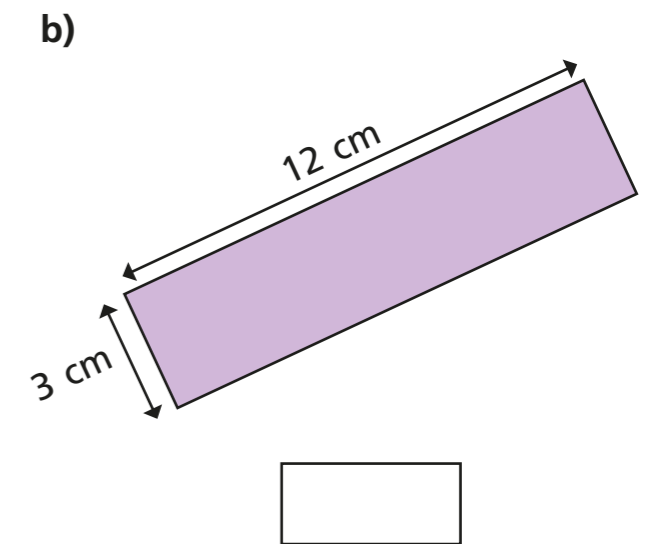

$$\square$$

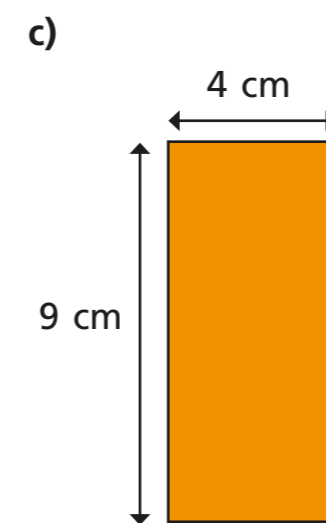

$$\square$$

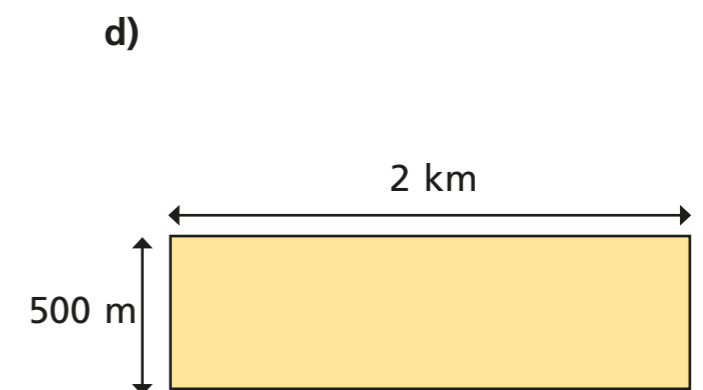

$$\square$$



- 3 Tommy is working out the perimeter of some rectangles.

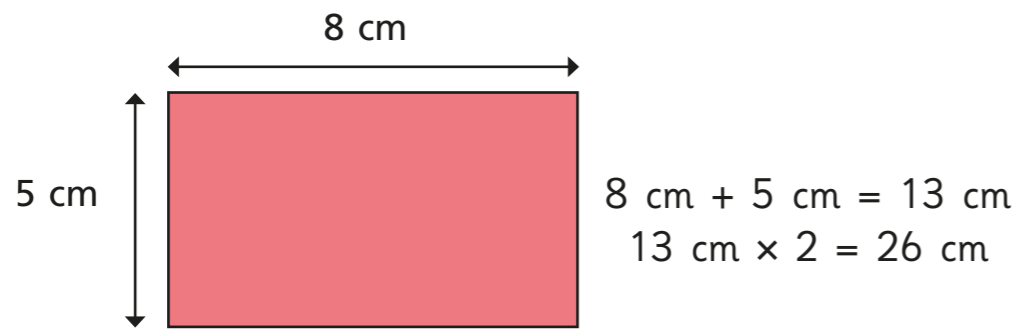

Use Tommy's method to find the perimeter of these rectangles.

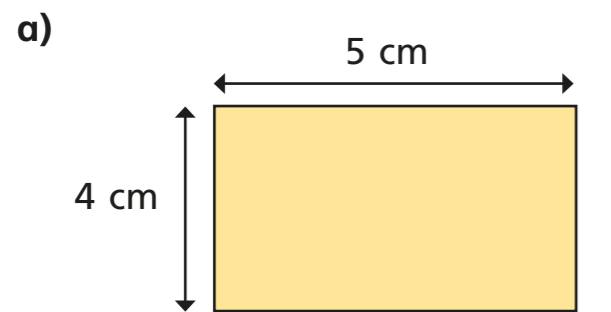

cm + cm = cm

cm \times 2 = cm

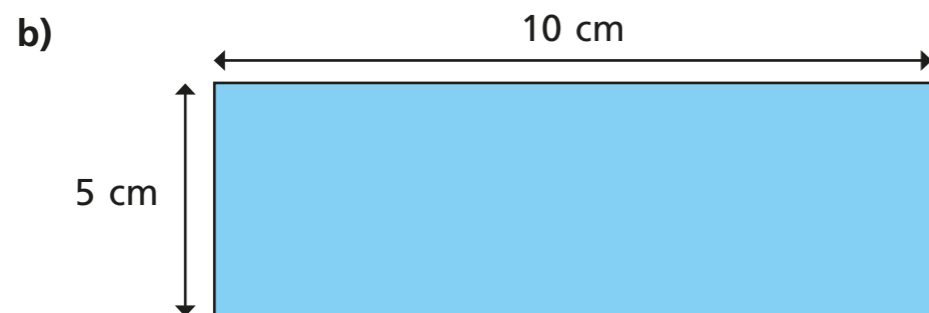

cm + cm = cm

cm \times 2 = cm

- 4 Each lolly stick is 8 cm long.
Find the perimeter of the shape.

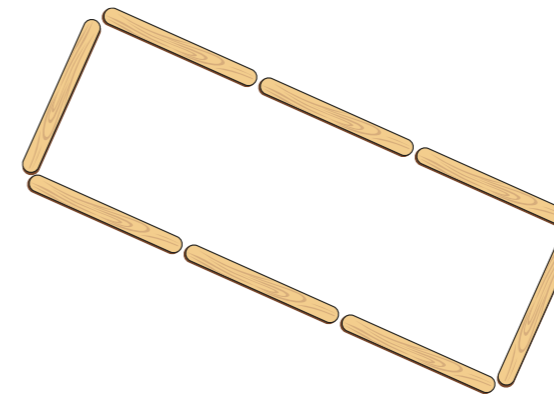

- 5 Each of these rectangles has a perimeter of 24 cm.
Work out the missing lengths and label the diagrams.

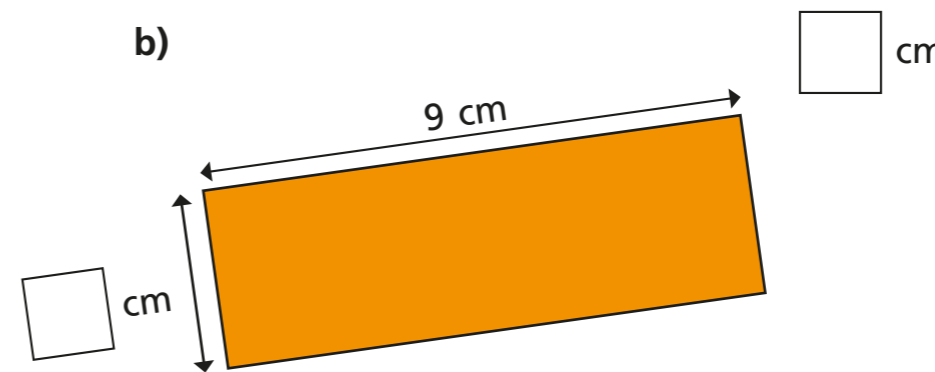
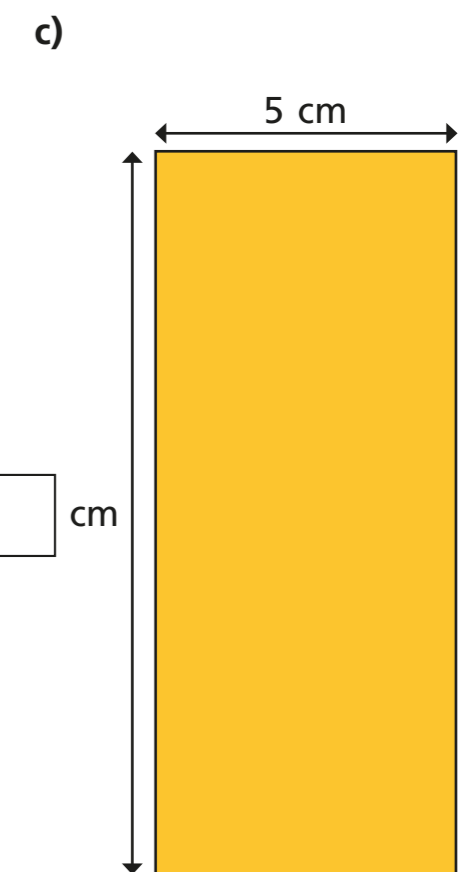
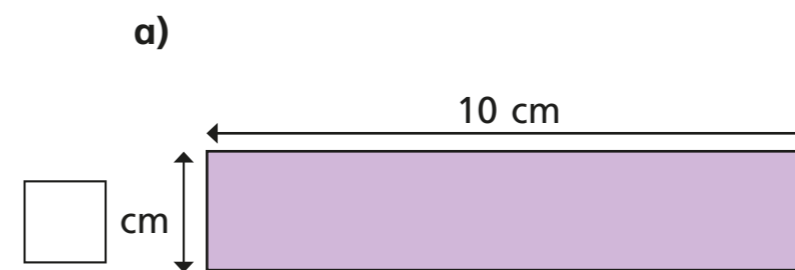

What do you notice?

Find any other rectangles that have the same perimeter.